

Pos.	Menge	Artikel-Nr.	Artikelbezeichnung	Länge	Breite
10*	2	0064136	Stellwand-Fußplatte D400 z		
20*	4	0062828	Profilrohr D30	950,00 mm	
30*	8	0062997	Anschluss 8 D30-90°		
40*	4	0062856	Rohr D30	50,00	
50*	8	0062356	Verbinder D30		
60*	1	0047306	Vollkunststoff 10mm, weiß	605,00	600,00

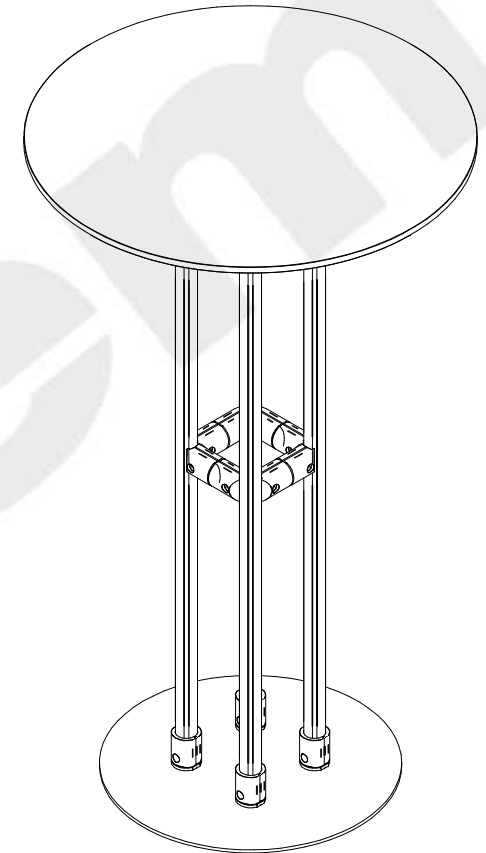

Maßstab	15	Allgemeintoleranz DIN ISO 2768 -mK Schutzvermerk DIN ISO 15016 beachten			Bezeichnung	Stehisch	Blatt 1 Blatt 5 von 1
		KL-Nr.	69629		AN-Nr.		
item Didaktik	2013	Tag	Name	AN-Nr.			
	Bearb.	02.05	chiel	Kunde	item		

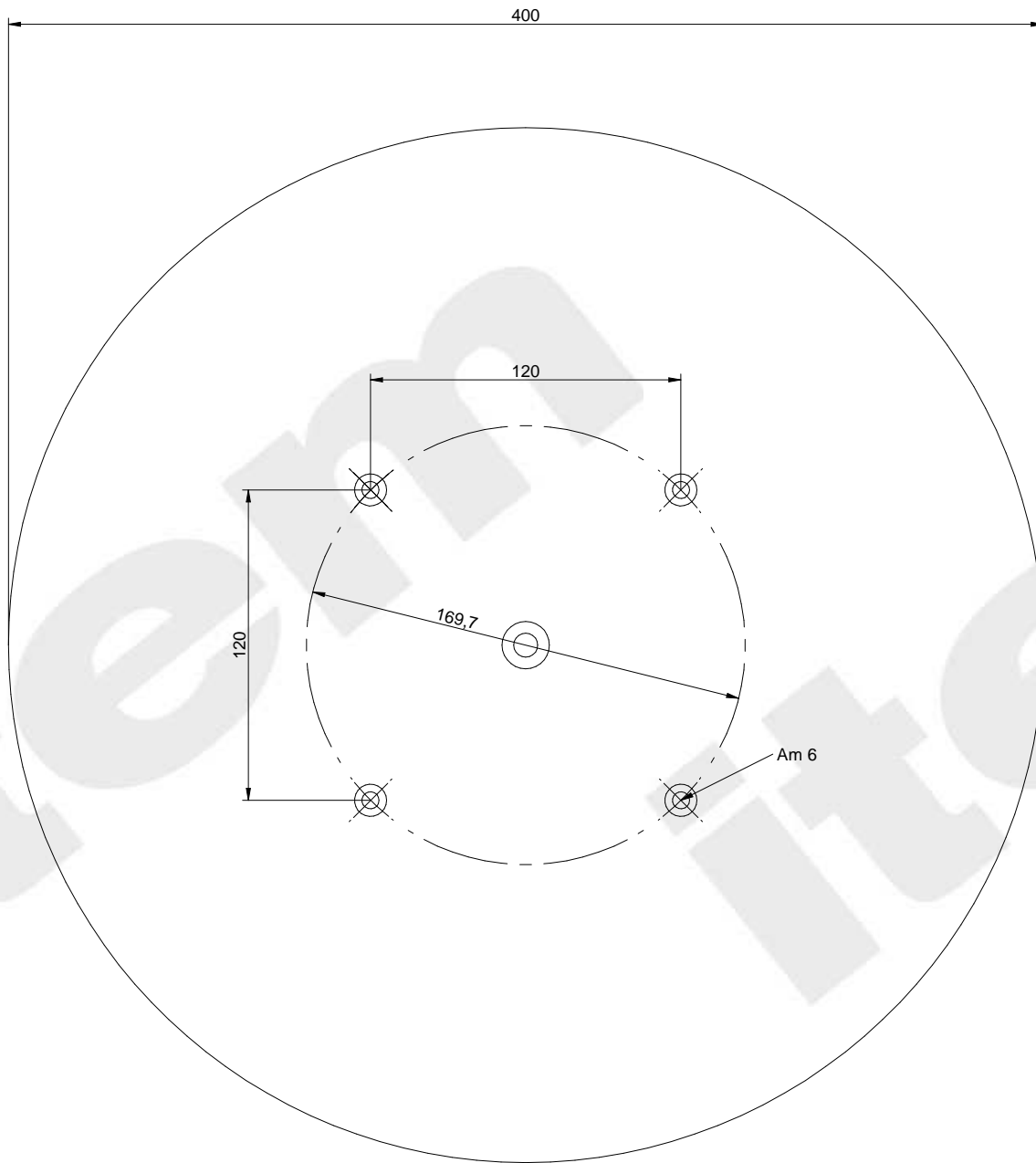

Platte unten

Massstab 1:2 item Didaktik	Allgmeintoleranz DIN ISO 2768-mK Schutzvermerk DIN ISO 16016 beachten			Bezeichnung: Stehtisch KL-Nr.: 69629	Blatt 2 Blatt 5 von 2
	Bearb. 02.05	Tag	Name thiel	AN-Nr.: Kunde: item	
G:\Produktmarketing_Digitale Medien\Projekte\Anwendungsbeispiele\AWB Update Mai 2013\Lean-Factory					

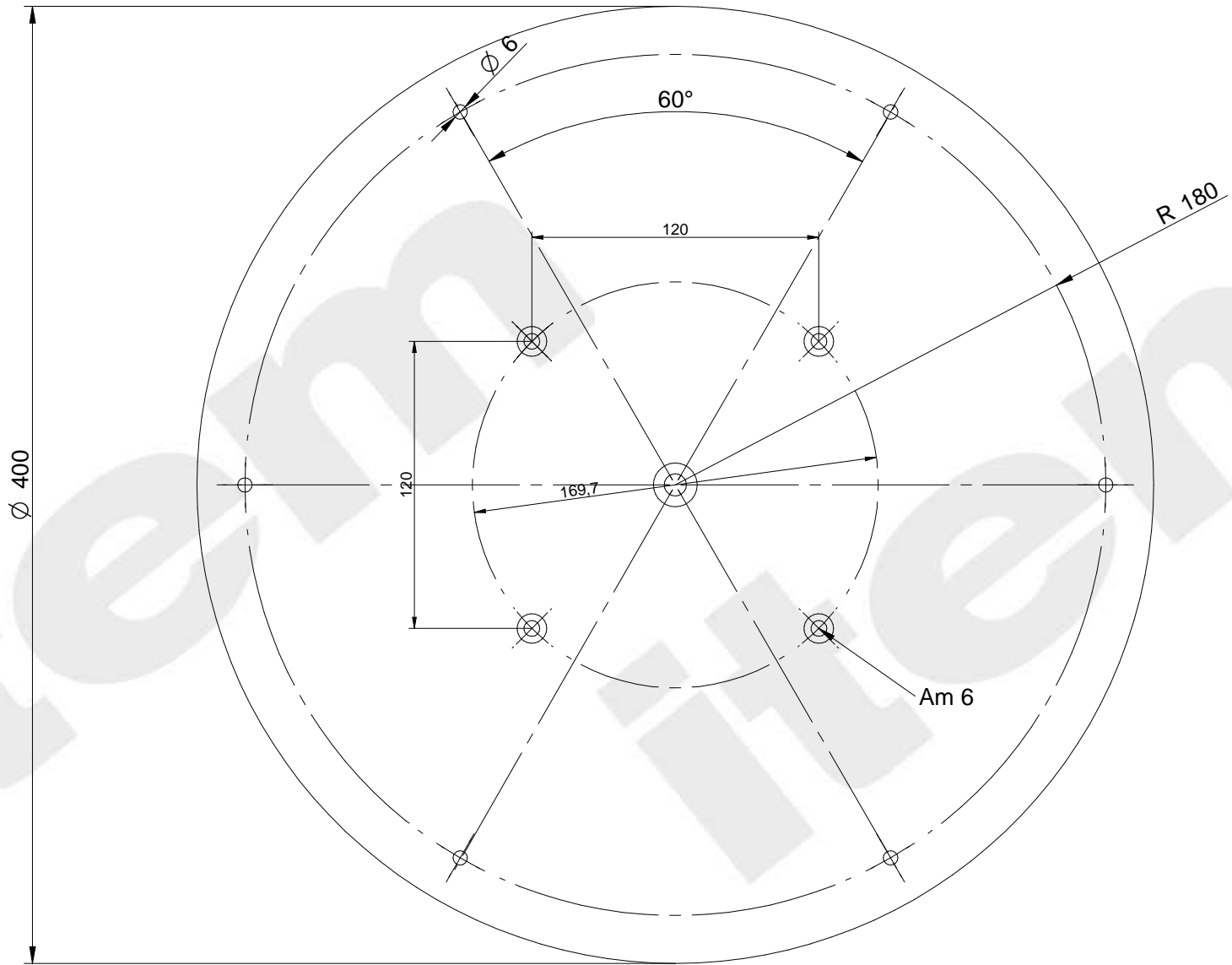

Platte oben

Massstab 1:2 item Didaktik	Allgmeintoleranz DIN ISO 2768 -mK Schutzvermerk DIN ISO 16016 beachten			Bezeichnung: Stehtisch KL-Nr.: 69629	Blatt3 Blatt 5 von 3
	Bearb. 02.05	Tag	Name thiel	AN-Nr.: Kunde: item	
G:\Produktmarketing_Digitale_Medien\Projekte\Anwendungsbeispiele\AWB Update Mai 2013\Lean-Learn Fact					

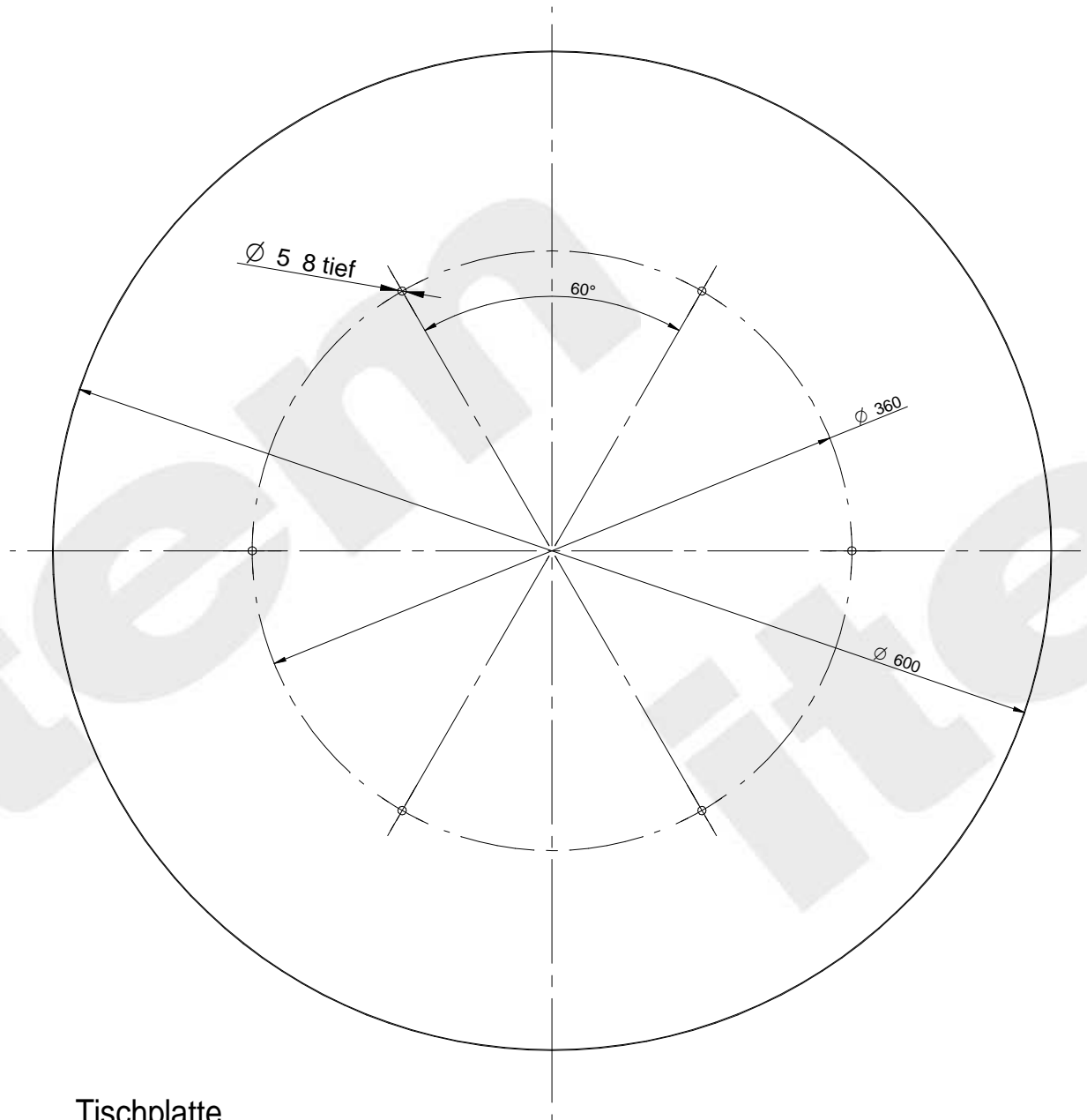

Tischplatte

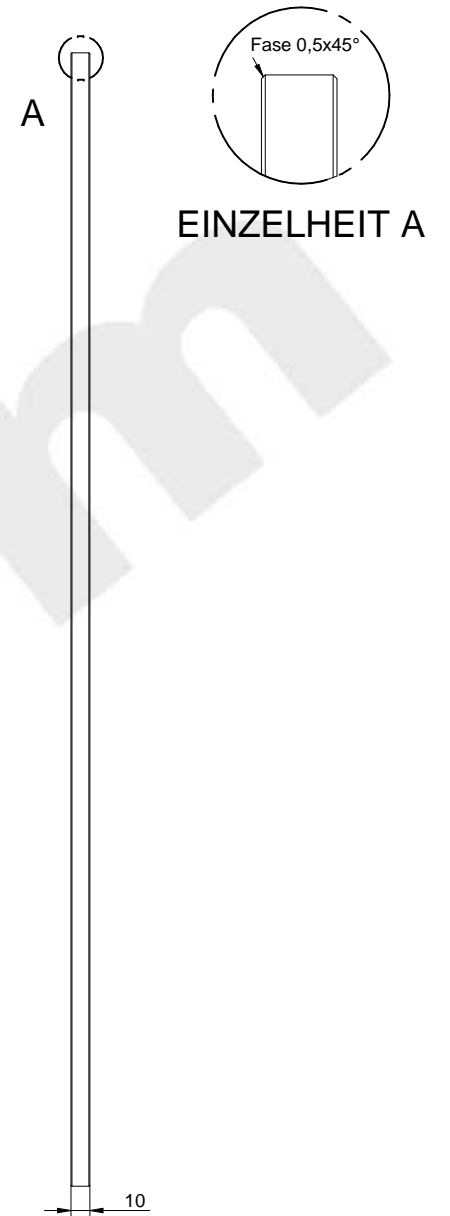

EINZELHEIT A

Massstab 1:2 item Didaktik	Allgmeintoleranz DIN ISO 2768-mK Schutzvermerk DIN ISO 15016 beachten			Bezeichnung: Stehtisch KL-Nr.: 69629	Blatt4 Blatt 5 von 4
	2013 Bearb. 02.05	Tag cthiel	Name Kunde: item	AN-Nr.: AN-Nr.:	
G:\Produktmarketing_Digitale_Medien\Projekte\Anwendungsbeispiele\AWB Update Mai 2013\Lean-Factory					

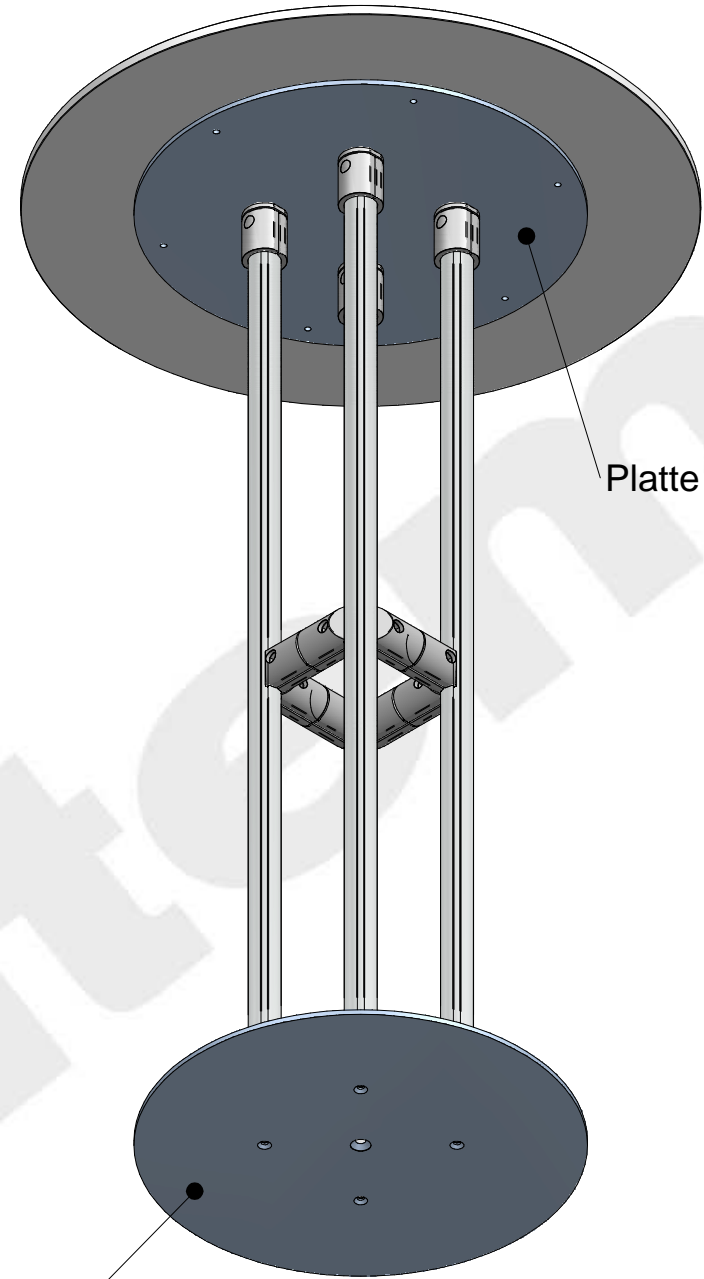
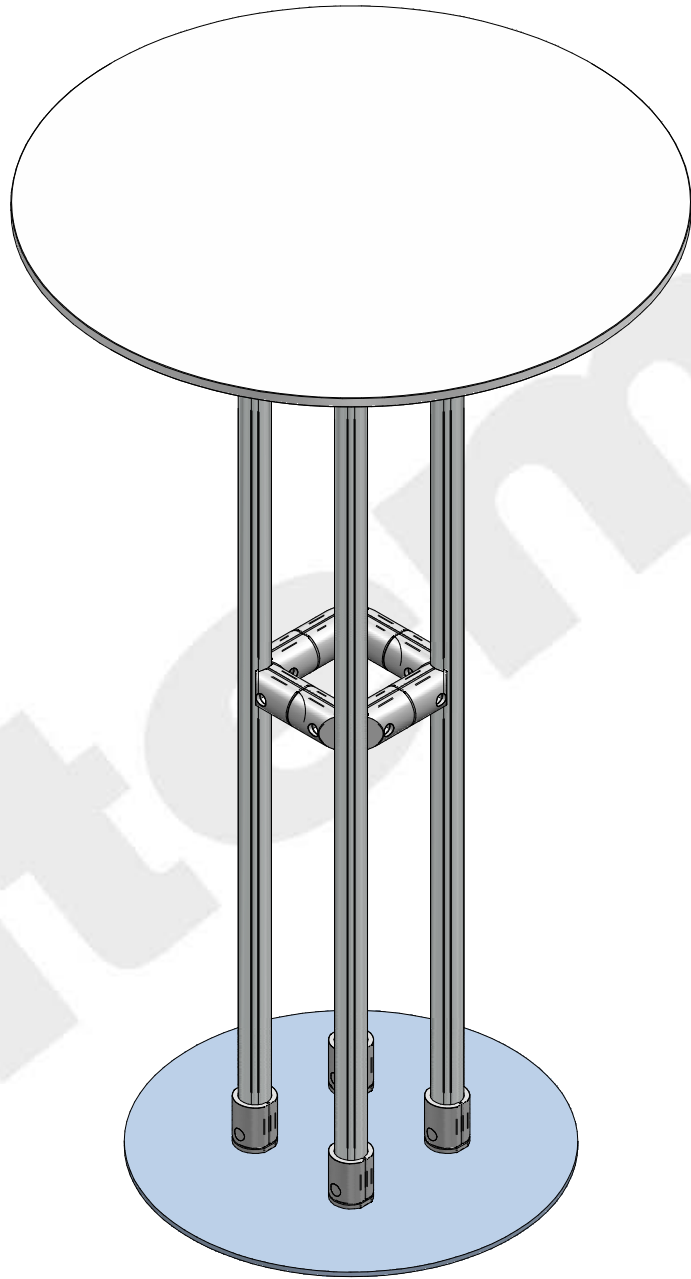

Platte oben

Platte unten

Masstab 1:10 item Didaktik	Allgemeintoleranz DIN ISO 2768 -mK Schutzvermerk DIN ISO 16016 beachten			Bezeichnung: Stehtisch KL-Nr.: 69629	Blatt5 Blatt 5 von 5
	2013 Bearb. 02.05	Tag chiel	Name chiel	AN-Nr.: Kunde: item	
G:\Produktmarketing Digitale Medien\Projekte\Anwendungsbeispiele\AWB Update Mai 2013\Lean-Factory					