

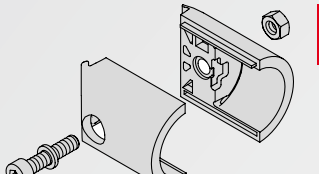

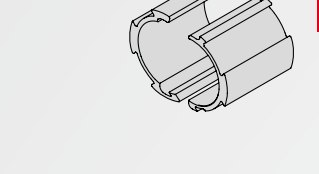

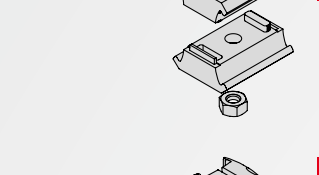
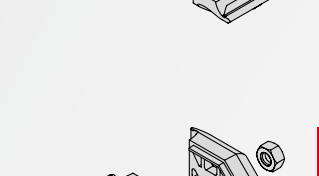
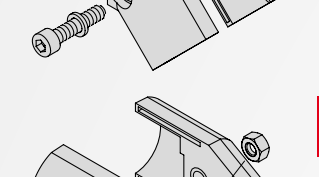
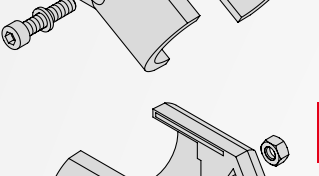
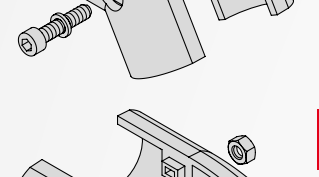

# Die Baureihe D30 – LPS

## 1 PROFILE / ZUBEHÖR

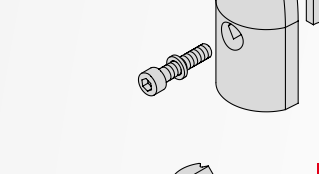
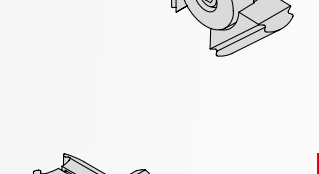
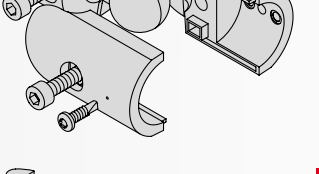
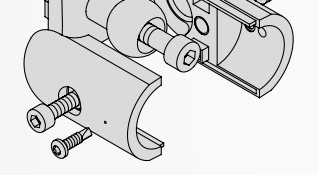
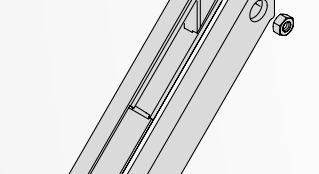
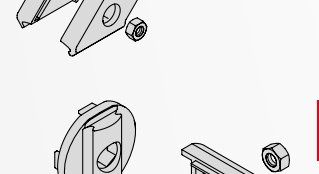
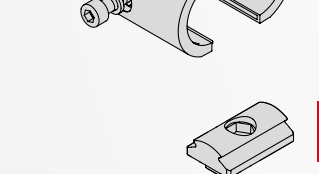
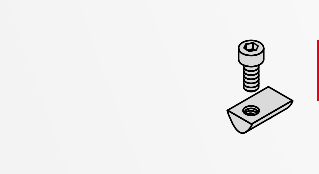
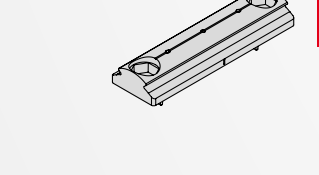
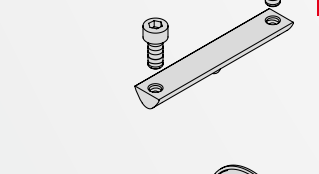
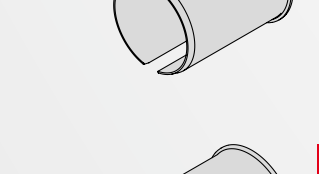
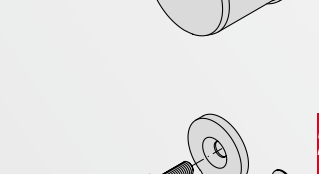
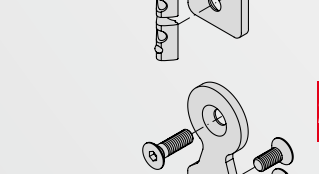
-  **1.1** Rohr D30  
0.0.628.52 natur
-  **1.2** Profilrohr D30  
0.0.628.17 natur  
0.0.643.21 schwarz ESD  
0.0.643.14 rot  
0.0.643.15 gelb  
0.0.643.16 grün  
0.0.643.17 blau  
0.0.643.18 grau  
0.0.643.19 weiß
-  **1.3** Profil 6 D30  
0.0.616.45 natur
-  **1.4** Profil 6 D30 1N  
0.0.615.08 natur
-  **1.5** Profil 6 D30 2N90  
0.0.615.11 natur
-  **1.6** Profil 6 D30 2N180  
0.0.614.23 natur
-  **1.7** Profil 6 D30 3N  
0.0.615.16 natur
-  **1.8** Profil 6 D30 4N  
0.0.616.48 natur
-  **1.9** Profilrohr D30 schwer  
0.0.642.33 natur
-  **1.10** Rohr KH D30x11,6  
0.0.643.70 anthrazit
-  **1.11** Schutzrohr D30x13  
0.0.641.23 grau
-  **1.12** Schutzrohr D30 Verschlussklipp  
0.0.654.04
-  **1.13** Abdeckkappe Rohr D30  
0.0.629.78  
0.0.637.04 ESD
-  **1.14** Abdeckkappe Profilrohr D30 schwer  
0.0.648.68  
0.0.649.35 ESD
-  **1.15** Abdeckkappe 6 D30  
0.0.634.45  
0.0.637.03 ESD
-  **1.16** Abdeckkappe Rohr KH D30  
0.0.649.31
-  **1.17** Rohrendkappe D30  
0.0.643.96  
0.0.644.65 ESD

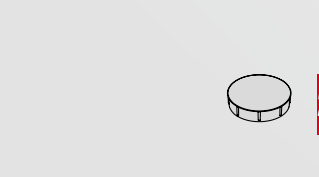
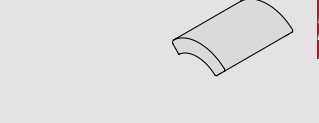
## 2 VERBINDUNGSTECHNIK

-  **2.1** Verbinder D30  
0.0.623.56
-  **2.2** Rohradapter D30  
0.0.630.61
-  **2.3** Parallelverbinder D30  
0.0.629.94
-  **2.4** Kreuzverbinder D30  
0.0.637.90
-  **2.5** Verbinder D30-45°  
0.0.637.87
-  **2.6** Stoßverbinder D30-30°  
0.0.646.10
-  **2.7** Stoßverbinder D30-60°  
0.0.646.94
-  **2.8** Stoßverbinder D30-90°  
0.0.647.02
-  **2.9** Winkelverbinder D30  
0.0.630.60
-  **2.10** Kugelverbinder D30  
0.0.646.85
-  **2.11** Kugelverbinder 8 D30  
0.0.650.98
-  **2.12** Winkelstrebe D30-90°  
0.0.629.95
-  **2.13** Anschluss 8 D30-90°  
0.0.629.97
-  **2.14** Adapter 8 D30  
0.0.630.51
-  **2.15** Befestigungssatz 8 D30  
0.0.653.82
-  **2.16** Adapter 8 80 D30  
0.0.653.24
-  **2.17** Befestigungssatz 8 80 D30  
0.0.653.06
-  **2.18** Adapter D30/D28-37  
0.0.638.88
-  **2.19** Adapter D30/D28-25  
0.0.642.62
-  **2.20** Rohrhalter 6 D30  
0.0.642.23
-  **2.21** Rohrhalter 8 D30  
0.0.642.05
-  **2.22** Verdrehsicherung 6 D30  
0.0.630.39
-  **2.23** Verdrehsicherung 6 D30-45°  
0.0.630.40
-  **2.24** Abdeckkappe D30 R  
0.0.624.11
-  **2.25** Abdeckkappe D30 F  
0.0.629.80
-  **2.26** Abdeckkappe Rohradapter D30  
0.0.630.23



## 3 BEFESTIGUNGSELEMENTE

-  **3.1** Gewindeeinsatz D30  
0.0.641.00 M6  
0.0.640.99 M6 ESD  
0.0.640.96 M8  
0.0.640.98 M8 ESD  
0.0.634.36 M10  
0.0.640.82 M10 ESD
-  **3.2** Gewindeeinsatz Profilrohr D30 schwer M12  
0.0.648.64
-  **3.3** Multiblock D30  
0.0.629.96
-  **3.4** Flächenbefestigung D30  
0.0.630.74
-  **3.5** Einfassprofil D30 3-5 mm  
0.0.649.29  
0.0.652.81 ESD
-  **3.6** Tischplattenbefestigung D30  
0.0.646.91
-  **3.7** Tischplatteneinhängung Strebe D30  
0.0.647.11
-  **3.8** Klemmschelle D30  
0.0.630.83
-  **3.9** Haken- und Halteradapter D30  
0.0.644.57 grau  
0.0.645.27 schwarz
-  **3.10** Beschriftungsprofil D30-100  
0.0.644.69
-  **3.11** Beschriftungsprofil D30-100 flex  
0.0.644.71
-  **3.12** Flansch D30-90x90  
0.0.655.54

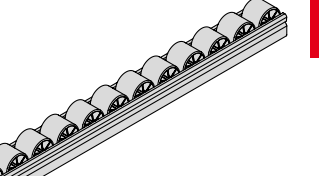
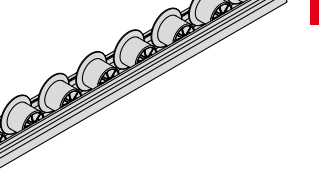
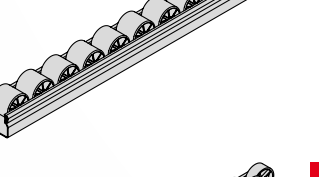
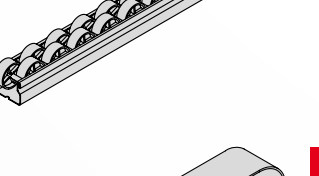
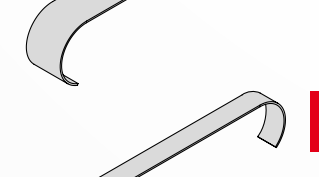
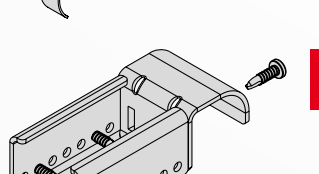
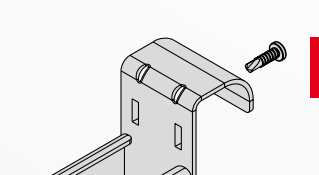
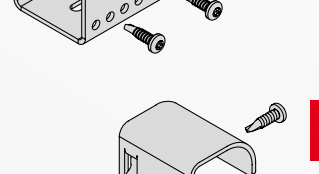
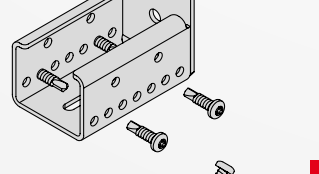
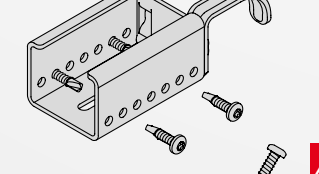
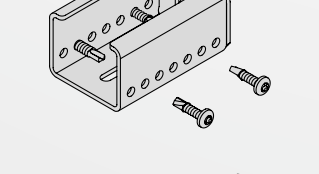
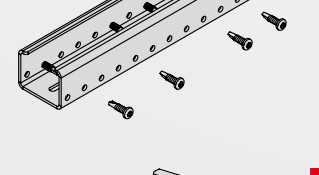
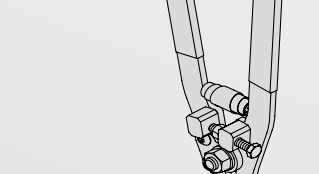
## 4 MATERIALFLUSS Rollenbahn St D30

-  **4.1** Rollenbahn St D30  
0.0.633.91  
0.0.637.55 ESD
-  **4.2** Rollenbahn St D30 mit Bordscheibe  
0.0.633.92  
0.0.637.56 ESD
-  **4.3** Rollenbahn St D30 stahlbereit  
0.0.650.74
-  **4.4** Rollenbahn St D30/2  
0.0.648.91  
0.0.648.94 ESD
-  **4.5** Rollenbahn St D30 Bremse  
0.0.647.76
-  **4.6** Rollenbahn St D30/2 Bremse  
0.0.650.55
-  **4.7** Rollenbahn St Aufnahme D30  
0.0.642.47
-  **4.8** Rollenbahn St Aufnahme D30 mit Anschlag H27  
0.0.642.46
-  **4.9** Rollenbahn St Aufnahme D30 mit Anschlag H43  
0.0.652.46
-  **4.10** Rollenbahn St Aufnahme U D30  
0.0.647.07
-  **4.11** Rollenbahn St Aufnahme I D30  
0.0.647.06
-  **4.12** Rollenbahn St Stoßverbinder  
0.0.654.75
-  **4.13** Rollenbahn St Montagezange  
0.0.654.73

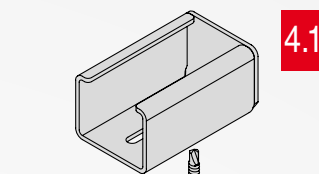
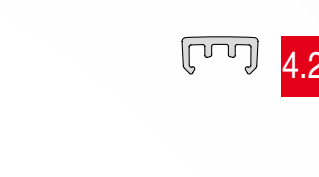
## 5 MATERIALFLUSS Rollenbahn AI D30

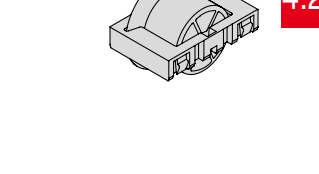
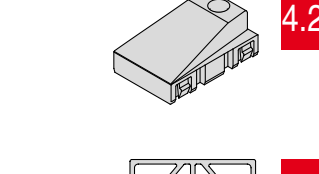
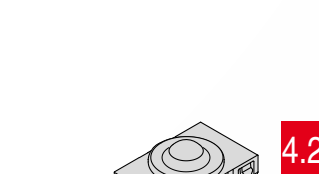
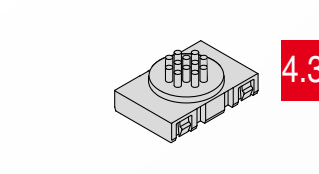
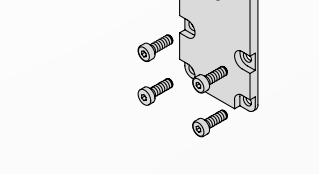
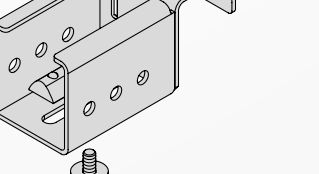
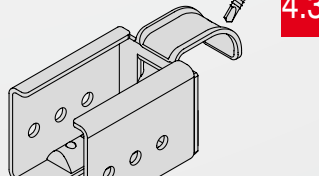
-  **4.14** Rollenbahn St Unterstützung D30  
0.0.647.10
-  **4.15** Rollenbahn St Endabdeckung  
0.0.647.08
-  **4.16** Rollenbahn St Führungsschiene e 65  
0.0.639.01  
0.0.641.77 ESD
-  **4.17** Rollenbahn St Führungsschiene e 32  
0.0.648.71  
0.0.648.73 ESD
-  **4.18** Halteblech Führungsschiene e  
0.0.650.83
-  **4.19** Rollenbahn St Führungsschiene z  
0.0.639.05  
0.0.641.78 ESD
-  **4.20** Rollenbahn Aufnahme Adapterhülse D30 ESD  
0.0.648.74
-  **4.21** Gleitleiste D30  
0.0.634.42  
0.0.634.55 ESD
-  **4.22** Rollenschiene 8 40x40  
0.0.626.91
-  **4.23** Rolleneinsatz D30  
0.0.620.16 schwarz  
0.0.622.27 schwarz ESD  
0.0.627.08 grün  
0.0.627.07 gelb  
0.0.627.06 rot
-  **4.24** Rolleneinsatz D30 mit Bordscheibe  
0.0.620.06 schwarz  
0.0.622.28 schwarz ESD  
0.0.627.11 grün  
0.0.627.10 gelb  
0.0.627.09 rot
-  **4.25** Rollenschiene 8 40x40, Bremse  
0.0.619.34
-  **4.26** Rolleneinsatz 4x11  
0.0.644.55  
0.0.648.98 ESD
-  **4.27** Gleitkeileinsatz ESD  
0.0.620.84
-  **4.28** Rollenschiene 8 40x40, Gleitleiste ESD  
0.0.622.26
-  **4.29** Kugelrolleneinsatz ESD  
0.0.620.26
-  **4.30** Bürsteneinsatz ESD  
0.0.622.22
-  **4.31** Rollenschiene 8 Abdeckplatte 40x40  
0.0.622.29
-  **4.32** Rollenschiene 8 Abdeckplatte 80x40  
0.0.622.30
-  **4.33** Rollenbahn AI Aufnahme D30  
0.0.652.48
-  **4.34** Rollenbahn AI Aufnahme D30 mit Anschlag H43  
0.0.652.57
-  **4.35** Rollenbahn AI Aufnahme U D30  
0.0.652.58
-  **4.36** Rollenbahn AI Aufnahme I D30  
0.0.652.64

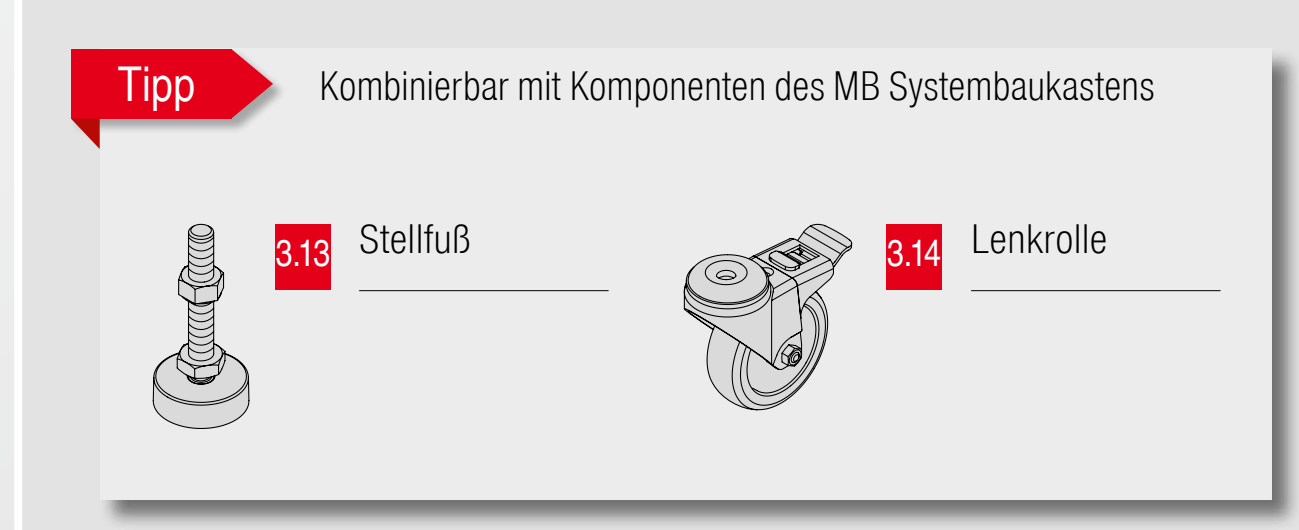
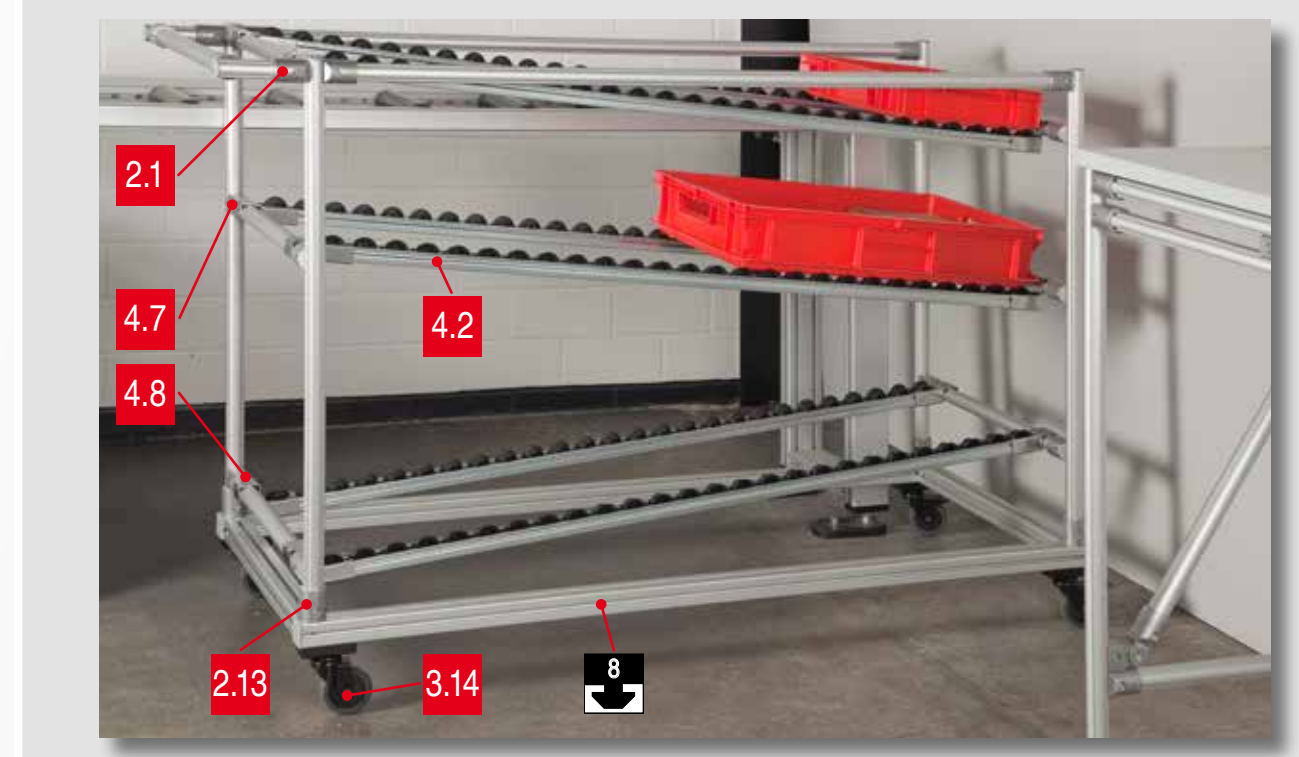
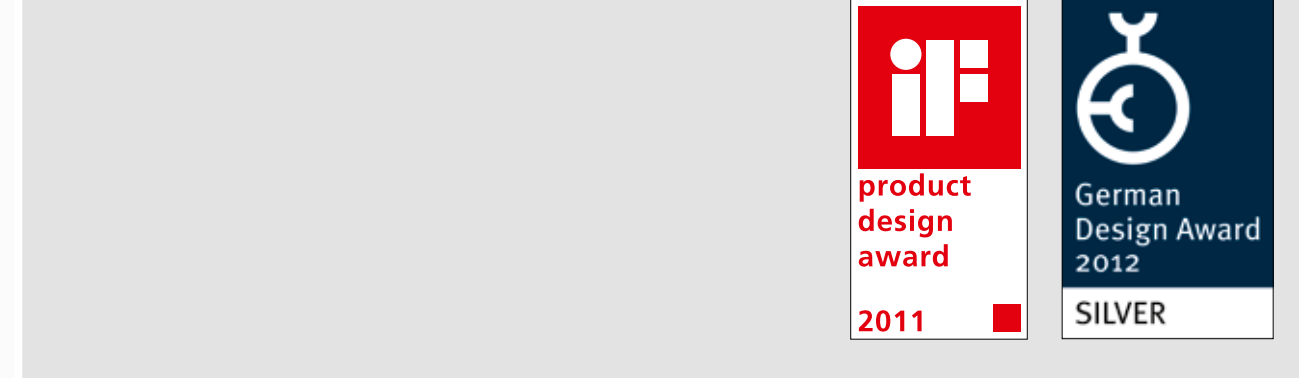



# Die Baureihe D30 – LPS



Längenerrechnungen Verbindungstechnik

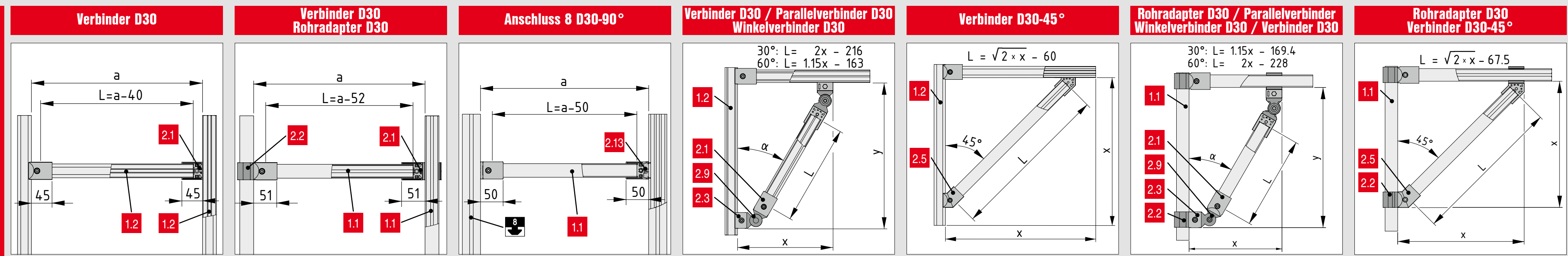

Längenerrechnungen Materialfluss

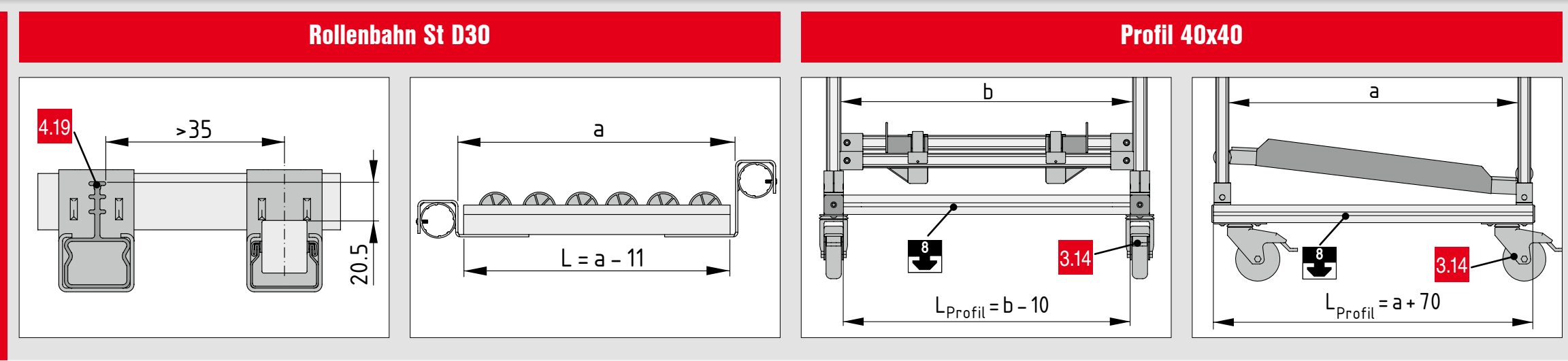

**Tip**

Schraubensicherung für dynamische Anwendungen.

Verbindungstechnik

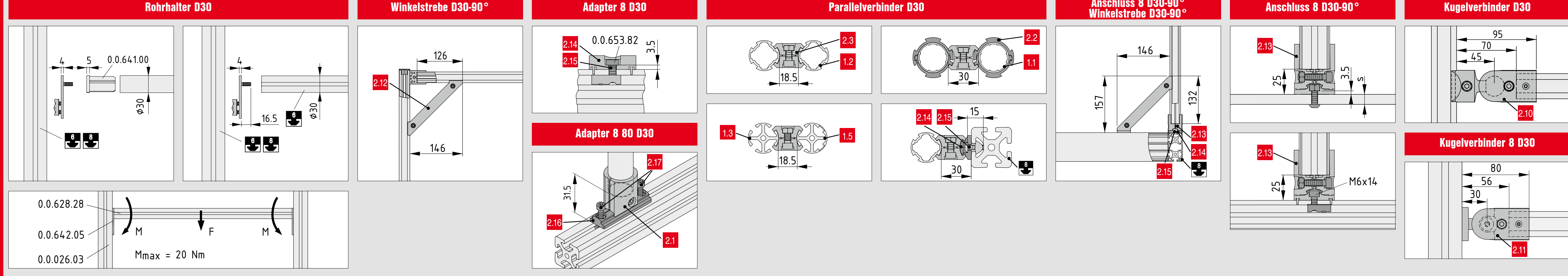

Materialfluss

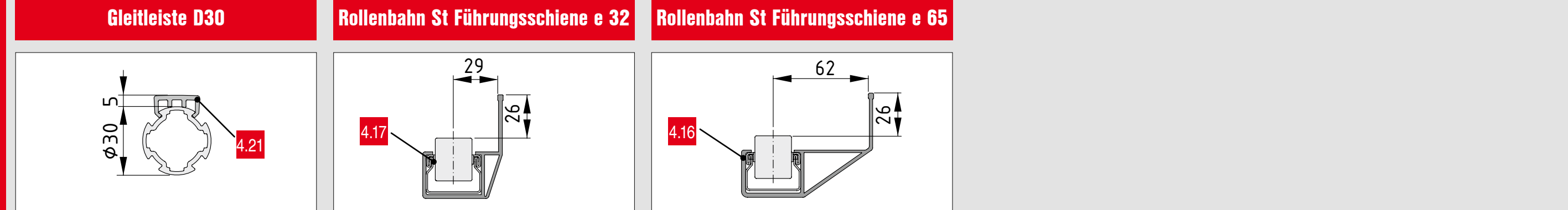

**Tip**

Fixierung durch selbstbohrende Schraube mit Bohrspitze.

**Tip**

ESD-taugliche Gestelle möglich.

Befestigungselemente

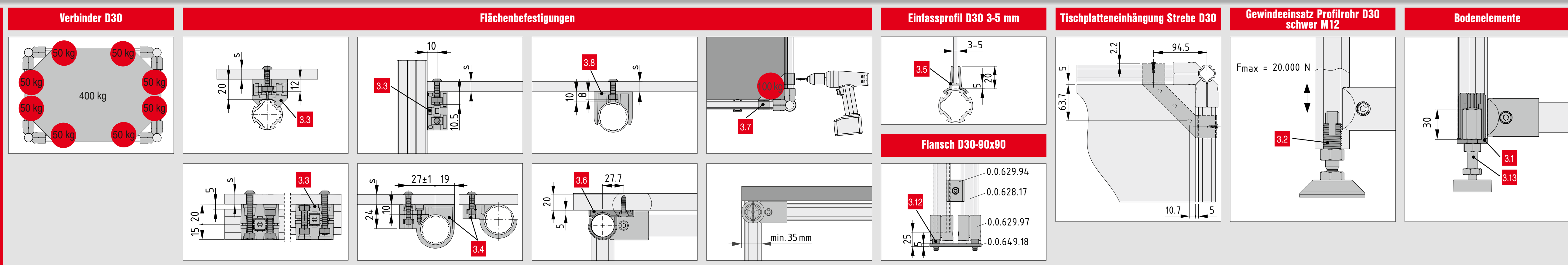

Belastungen

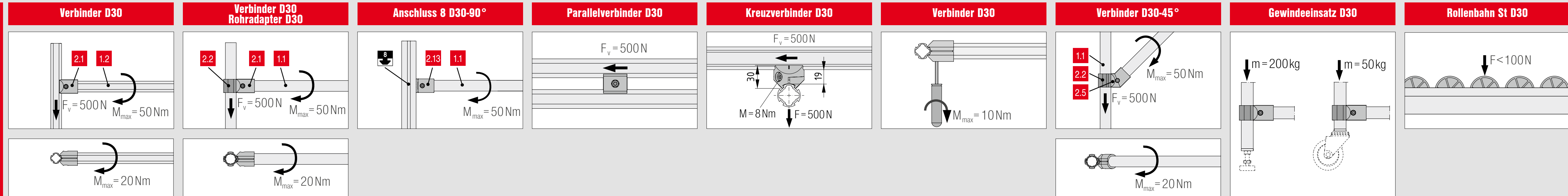

Durchbiegungen

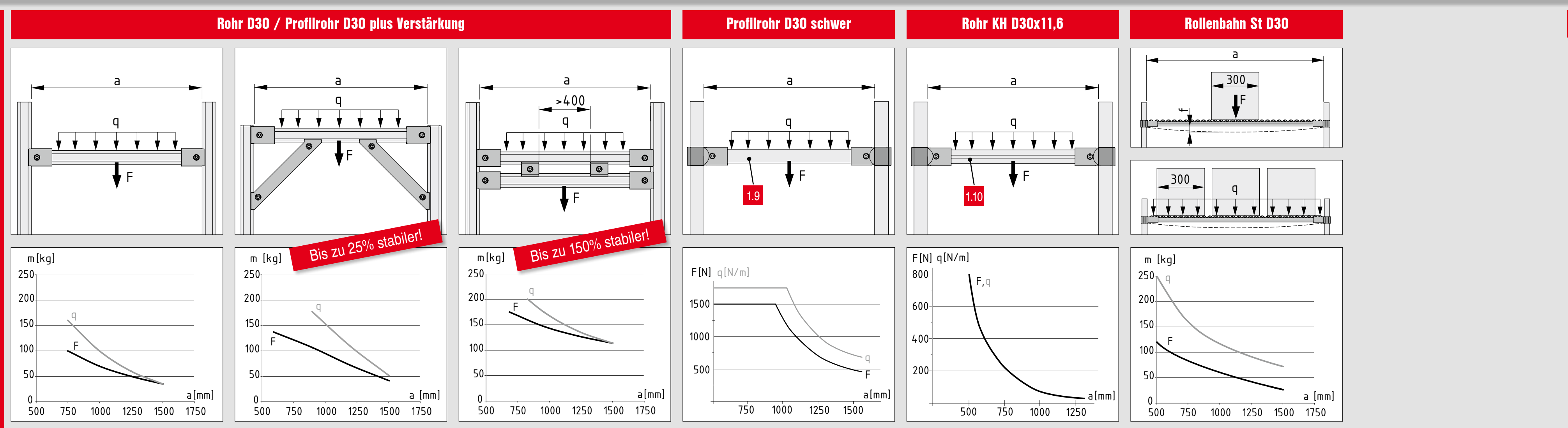

**Tip**

Abedeckkappe Rohradapter D30 zum Halten der beiden Rohradapter-Hälften.

Einbaumaße

Rollenbahn St D30 / Rollenbahn AI D30				Rollenbahn AI D30			
Rollenbahn St		Rollenbahn AI		Rollenbahn St		Rollenbahn AI	
Aufnahme D30 0.0.642.47	a = 17 mm b = 23 mm c = 14 mm d = 18 mm	Aufnahme D30 0.0.652.48	a = 17 mm b = 23 mm c = 28,5 mm d = 20,5 mm	Aufnahme D30 mit Anschlag H27 0.0.642.46	a = 17 mm b = 11 mm c = 48 mm d = 18 mm	Aufnahme D30 mit Anschlag H43 0.0.652.46	a = 17 mm b = 26 mm c = 63 mm d = 20,5 mm
Aufnahme U D30 0.0.647.07	a = 18 mm b = 23 mm c = 13 mm d = 20,5 mm	Aufnahme U D30 0.0.652.58	a = 18 mm b = 23 mm c = 28,5 mm d = 20,5 mm				
Aufnahme I D30 0.0.647.06	a = 18 mm b = 23 mm c = 13 mm d = 20,5 mm	Aufnahme I D30 0.0.652.64	a = 18 mm b = 23 mm c = 28,5 mm d = 20,5 mm				

- a: Kugelrolleneinsätze ESD
- b: Rolleneinsätze D30/Rolleneinsätze D30 mit Bordscheibe, optional ESD
- c: Rollenschiene 8 40x40, Bremse
- d: Rolleneinsätze 4x11
- e: Bürsteneinsätze ESD
- f: Gleitkeileinsatz ESD
- g: Rollenschiene 8 40x40, Gleitleiste ESD - Hocheinbau
- h: Rollenschiene 8 40x40, Gleitleiste ESD - Flacheinbau